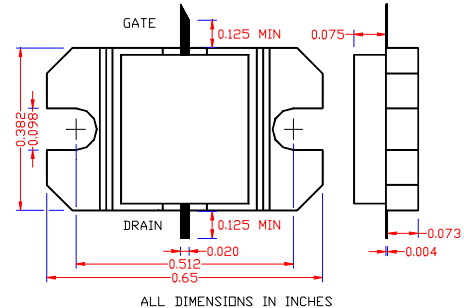

Not recommended for new designs. Contact factory. Effective 03/2003
13.75-14.5GHz, 8W Internally Matched Power FET

- 13.75-14.5GHz BANDWIDTH AND INPUT/OUTPUT IMPEDANCE MATCHED TO 50 OHM
- HIGH PAE(25% TYPICAL)
- +39dBm TYPICAL P_{1dB} OUTPUT POWER
- 7.0dB TYPICAL G_{1dB} POWER GAIN
- NON-HERMETIC METAL FLANGE PACKAGE

ELECTRICAL CHARACTERISTICS ($T_a = 25^\circ\text{C}$)

SYMBOLS	PARAMETERS/TEST CONDITIONS	EIA1314-8P						UNIT
		MIN	TYP	MAX				
P_{1dB}	Output Power at 1dB Compression $f=13.75-14.5\text{GHz}$ $V_{ds}=8\text{V}$, $I_{dsq}=0.5 I_{dss}$	38	39					dBm
G_{1dB}	Gain at 1dB Compression $f=13.75-14.5\text{GHz}$ $V_{ds}=8\text{V}$, $I_{dsq}=0.5 I_{dss}$	6.0	7.0					dB
PAE	Power Added Efficiency at 1dB compression $f=13.75-14.5\text{GHz}$ $V_{ds}=8\text{V}$, $I_{dsq}=0.5 I_{dss}$		25					%
I_{d1dB}	Drain Current at 1dB Compression		3520					mA
IP3	Output 3 rd Order Intercept Point $f=13.75-14.5\text{GHz}$ $V_{ds}=8\text{V}$, $I_{dsq}=0.5 I_{dss}$		46					dBm
I_{dss}	Saturated Drain Current $V_{ds}=3\text{V}$, $V_{gs}=0\text{V}$	4400	5760	6800				mA
G_m	Transconductance $V_{ds}=3\text{V}$, $V_{gs}=0\text{V}$		6000					mS
V_p	Pinch-off Voltage $V_{ds}=3\text{V}$, $I_{ds}=48\text{mA}$		-1.0	-2.5				V
BV_{gd}	Drain Breakdown Voltage $I_{gd}=19.2\text{mA}$	-13	-15					V
R_{th}	Thermal Resistance (Au-Sn Eutectic Attach)		2.3					$^\circ\text{C/W}$

MAXIMUM RATINGS AT 25°C

SYMBOLS	PARAMETERS	ABSOLUTE ¹	CONTINUOUS ²
V_{ds}	Drain-Source Voltage	12V	8V
V_{gs}	Gate-Source Voltage	-8V	-3V
I_{ds}	Drain Current	I_{dss}	6240mA
I_{gsf}	Forward Gate Current	720mA	120mA
P_{in}	Input Power	38dBm	@ 3dB Compression
T_{ch}	Channel Temperature	175 $^\circ\text{C}$	150 $^\circ\text{C}$
T_{stg}	Storage Temperature	-65/175 $^\circ\text{C}$	-65/150 $^\circ\text{C}$
P_t	Total Power Dissipation	60W	50W

Note: 1. Exceeding any of the above ratings may result in permanent damage.

2. Exceeding any of the above ratings may reduce MTTF below design goals.